



SKYWORKS™

Power Amplifier and Front-End Module Technology for 3.9G LTE/EUTRAN applications

Dr. Gene Tkachenko
Sr. Director of Engineering

- **Skyworks Development Team:**

- Dima Prikhodko,
- Hichem Abdalla,
- Sergey Nabokin,
- Hao Zhang,
- Alex Klimashov,
- Brad Barber,
- Jingwen Zhu,
- Christina Dearstine,
- Rich Carter,
- Victor Lopez

- **Many others at Skyworks who provided support**

- **Introduction – LTE**
- **RF Hardware requirements**
- **Device and Technology Solutions**
- **Summary**

LTE/EUTRAN Basics

- LTE = Long Term Evolution (of the WCDMA/HSPA 3GPP standards)
- EUTRAN = Evolved Universal Terrestrial Radio Access Network
- Mobile broadband technology
- Higher data rates (and capacity)
- Improved quality of service and latency
- Greater coverage

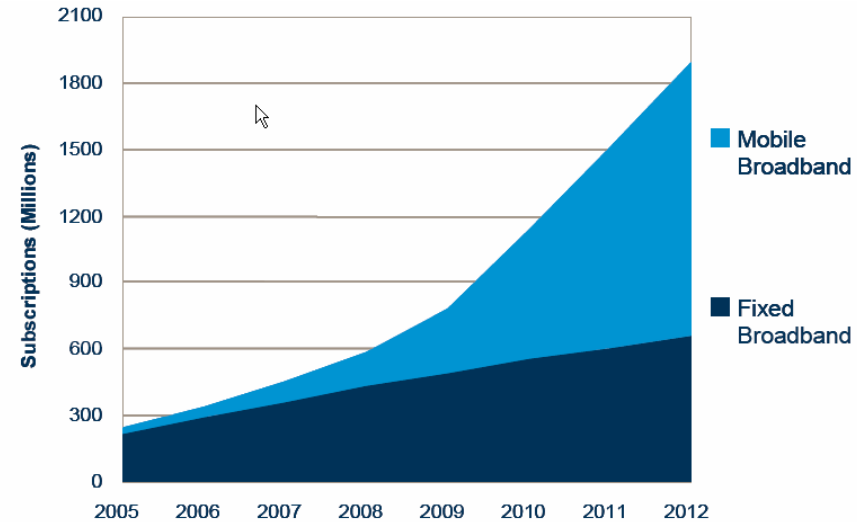

Source: OVUM, Strategy Analytics & Internal Ericsson

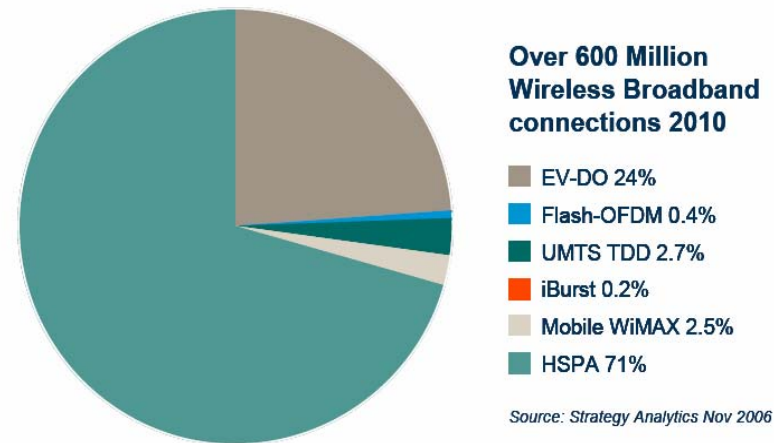

Source: Strategy Analytics Nov 2006

Evolution of 3GPP Family Standards

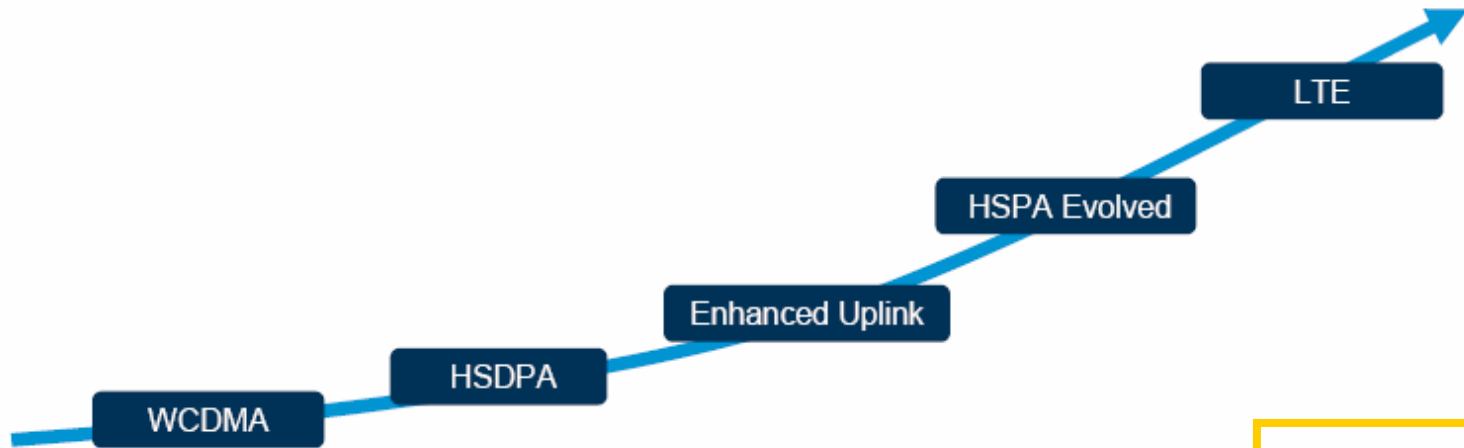

3GPP	R99/1999	R5/2002	R6/2005	R7/2007*	R8/2008**
Peak	0.384 Mbps DL	14 Mbps DL	14 Mbps DL	28/42 Mbps DL*	160 Mbps DL
Data Rate	0.064 Mbps UL	0.384 Mbps UL	6 Mbps UL	12 Mbps UL	50 Mbps UL
Commercial Availability	2001	2005	2006	2008	2009

*Expected: 28Mbps with MIMO, 42 Mbps with MIMO + 64QAM

**Expected: LTE specification ready end 2007

Spectral Efficiency and Peak Data rates of LTE vs. WiMAX

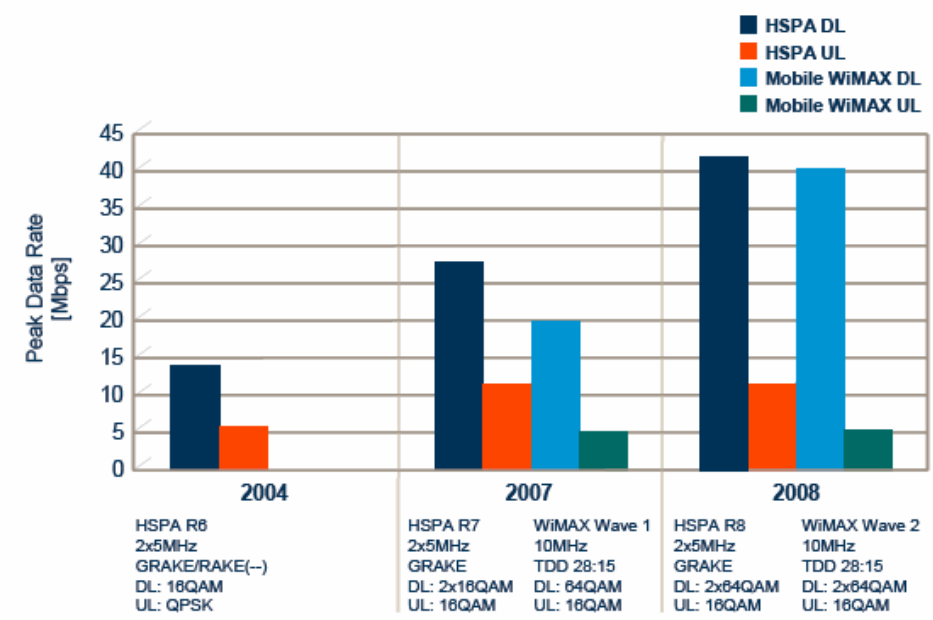
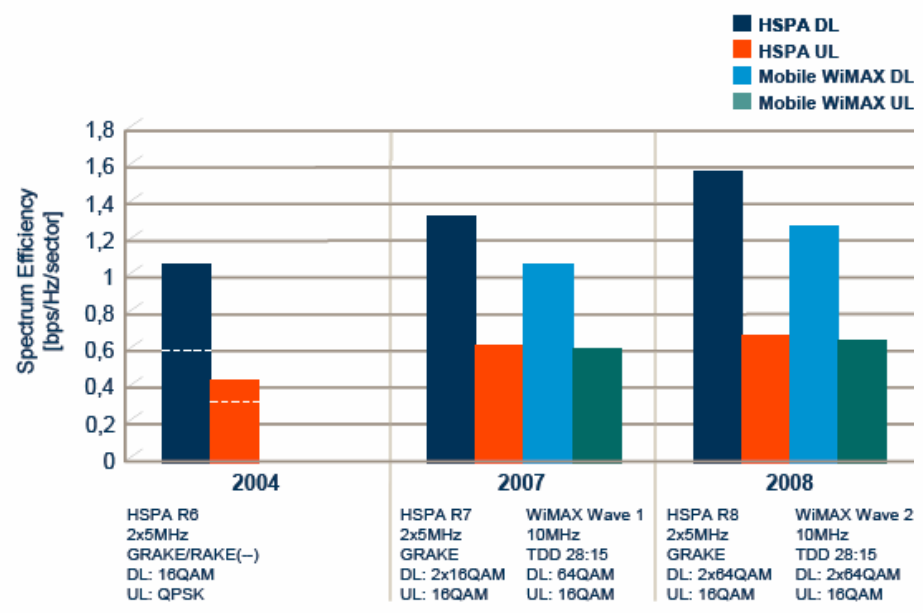

Source: Ericsson White Paper "Technical overview and performance of HSPA and Mobile WiMAX", September 2007

- **Similar: Network architecture, peak data rates, spectral efficiency**
- **Superior for LTE:**
 - Coverage (~2X fewer base stations required for equivalent BW)
 - Link budget
 - **Higher power 24dBm vs. 23dBm**
 - **FDD vs. TDD: higher average power due to continuous transmission**
 - Existing GSM network sites, Software upgrade to existing WCDMA network
 - HSPA: proven technology deployed in >100 networks worldwide
 - Lower cost of deploying the network (70% cost of land to place the BS's)

	HSPA	Mobile WiMAX
Physical signal format	DL code aggregation, UL DS-CDMA	OFDMA for both DL and UL
Hybrid ARQ with soft combining	Adaptive IR + Chase combining	Chase combining
Multi-level QoS	√	√
Link adaptation	QPSK, 16QAM, 64QAM Lowest code rate: 1/3	QPSK, 16QAM, 64QAM Lowest code rate: 1/2
Duplex scheme	FDD	TDD
Frequency bands	850MHz to 2,600MHz	2.3GHz, 2.6GHz and 3.4–3.8GHz
Handover	Hard handover, Soft handover	Hard handover
Frequency reuse one	√	√
Advance antenna technologies	<ul style="list-style-type: none"> • Closed- and open-loop transmit diversity • Spatial multiplexing • Beam-forming 	<ul style="list-style-type: none"> • Open-loop transmit diversity • Spatial multiplexing • Beam-forming

Verizon Adopts LTE For 4G Wireless Platform

TechWeb

By Elena Malykhina
InformationWeek
Thu Nov 29, 1:30 PM ET

TechWeb The Business Technology Network
www.techweb.com

Verizon on Thursday disclosed plans to roll out its fourth-generation mobile broadband network

Verizon, AT&T Big Winners In 700 MHz Auction

The two telecom companies bid more than \$16 billion, constituting the vast majority of the \$19.6 billion bid in the FCC spectrum auction.

Ericsson unveils M700 LTE platform for mobile devices

By W. Darren Murph, posted Apr 3rd 2008 at 6:28PM



Vendors hammer out LTE IP licensing rights

April 14, 2008

TAGS Sony Ericsson lucent Nextwave Wireless Alcatel

TOOLS Email Print Comment Contact Author

A half dozen telecom vendors have announced plans to commit to a framework for "predictable" and "more transparent" intellectual property licensing rights that would apply to LTE. Alcatel-Lucent, Ericsson, NEC, NextWave Wireless, Nokia, Nokia Siemens Networks and Sony Ericsson have specifically agreed to a maximum royalty level for LTE-essential IP rights in handsets that is only a single-digit percentage of the sales price. The same goes for laptops with embedded LTE functionality.

"The adoption of this initiative will reassure operators of the early widespread adoption of LTE technology throughout the consumer electronics industry," Ericsson's SVP, GM and CTO Håkan Eriksson said in a statement.

- **Initial Deployment targeting Band VII (2.6 GHz)**
 - First LTE phone call by EMP (Feb 2008, 3GSM)
 - Nokia "real world" LTE testing in 2.6GHz band
- **Followed by adoption in other bands is expected**
- **Recent US Auction of 700 MHz spectrum will result in accelerated LTE development and deployment in Bands XIII and XII**
 - \$16B spent by Verizon and AT&T on licenses
 - Participation and strong push by Google for "open access" zone

The san
the "wor
undoubt
of cours
happen
sometin

Front-End Architectures Including LTE

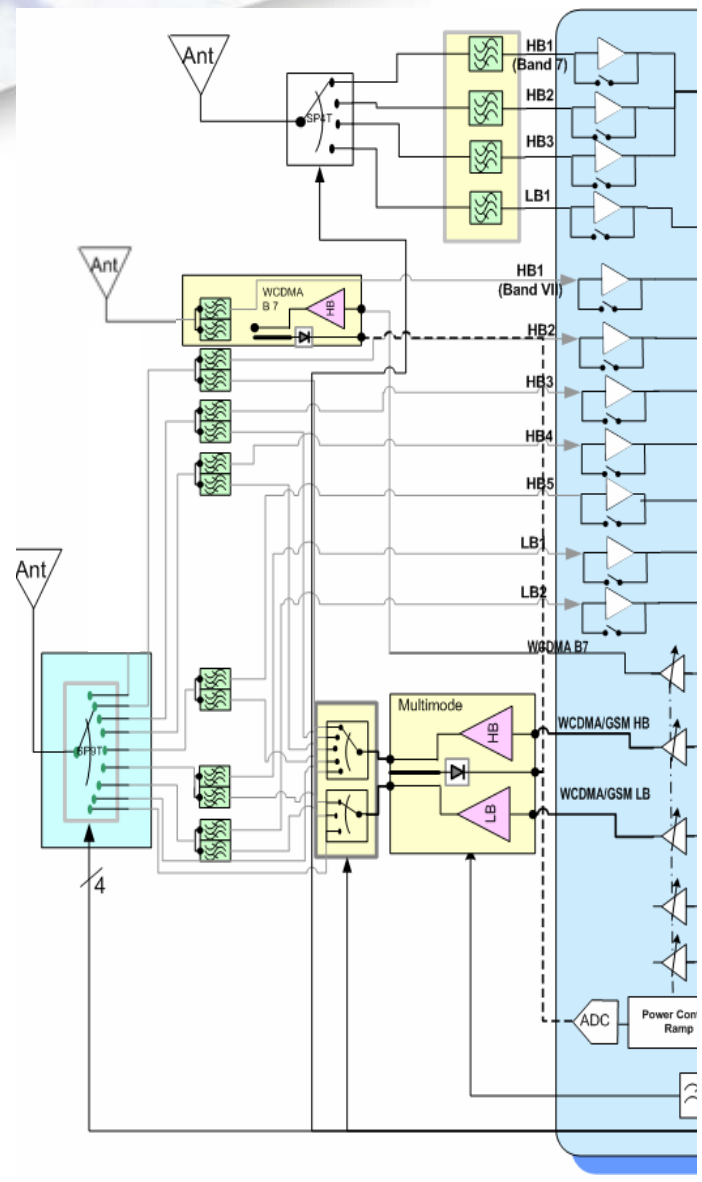

- Dedicated Band VII RFIC output and Amplifier chain
- Likely a dedicated Antenna for Band VII: 2.6GHz hard to match with all other bands on one Antenna
- Diversity RX supporting LTE MIMO
- Long-Term: Multi-Mode and Multi-Band PA's supporting LTE in multiple bands

- **Transceivers**

- MIMO: Lower noise floor → higher RX sensitivity required
- 2.6GHz: higher frequency and more difficult to get high linear power with low cost Si technology

- **Linear Power Amplifiers**

- More stringent linearity requirements, compared to HSDPA
- Higher Peak-to-Average-Ratio
- More challenging linear efficiency requirements

- **Linear Front-End Switches**

- Higher Linearity (IMD, IP3) required, compared to WCDMA, because of higher RX sensitivity and lower RX noise floor

- **High Quality Filters**

- Higher and lower frequency than conventional WCDMA with as challenging % BW and narrow TX-RX separation
- Higher Linearity required, as in the case of switches

SKY77445 – Industry's First Band VII Front-End Module for LTE/EUTRAN 3.9G

- **Fully matched, highly integrated 4x7x1.2 mm module containing:**

- Inter-stage filter
- Input matching
- Power amplifier
- Output matching
- Power detection
- Duplexer

- **Supports Band VII LTE/EUTRAN requirements:**

- QPSK, 16QAM, 64QAM modulations
- 1.25, 2.5, 5, 10, 20MHz bandwidths
- Up to 100 resource blocks
- >23dBm linear power at 3.3V
- Excellent isolation: typ. >50dB TX-RX
- Excellent linearity: typ. EVM<3%

- **State-of-the-art technologies:**

- BAW Filters
- InGaP BiFET PA
- MCM Packaging

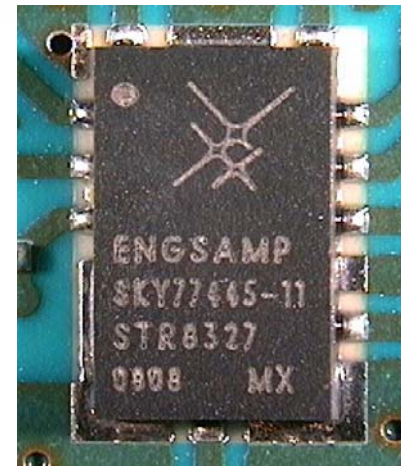
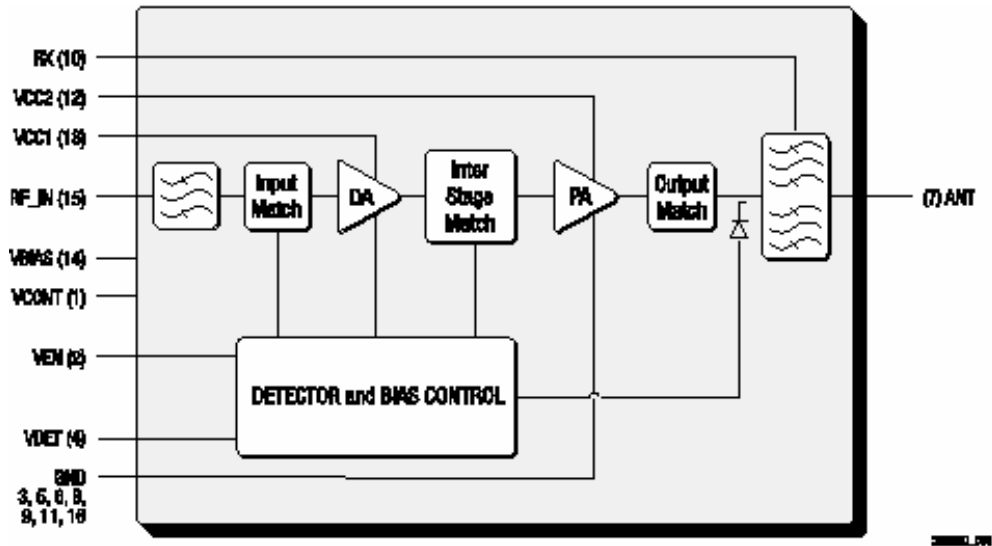

State-of-the-Art FEM, 50% smaller than individual components combined

Optimization for High Gain

- **FEM integration:**
 - allows optimal in-band and out-of-band matching between individual components
 - not necessarily at 50 Ohms
- **Results in improved link budget and high gain**
- **Individual components don't need to be over-specified (e.g. meet all specs over VSWR)**
- **Less stringent Transceiver requirements**

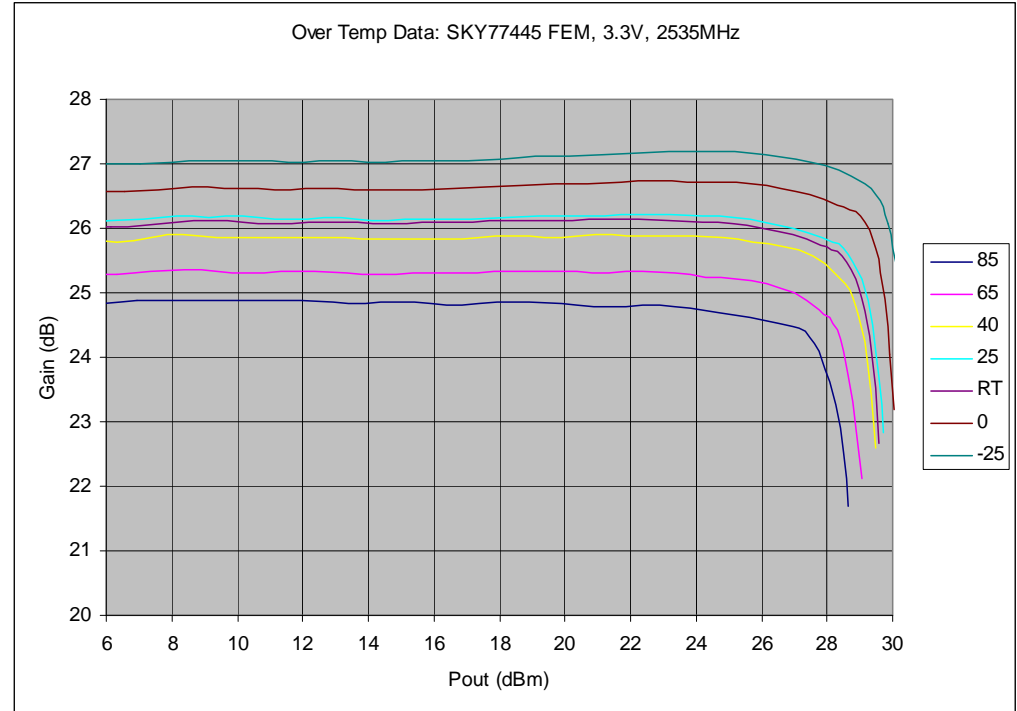

Linear Operation at 4-5dB back-off from P1dB

Integration Resulting in Optimal Performance

FEM Linearity Performance (ACPR1)

LTE and WCDMA: 3.3V, 2500, 2535 and 2570 MHz

LTE

ACPR1: LTE-16QAM-10MHz-50RB

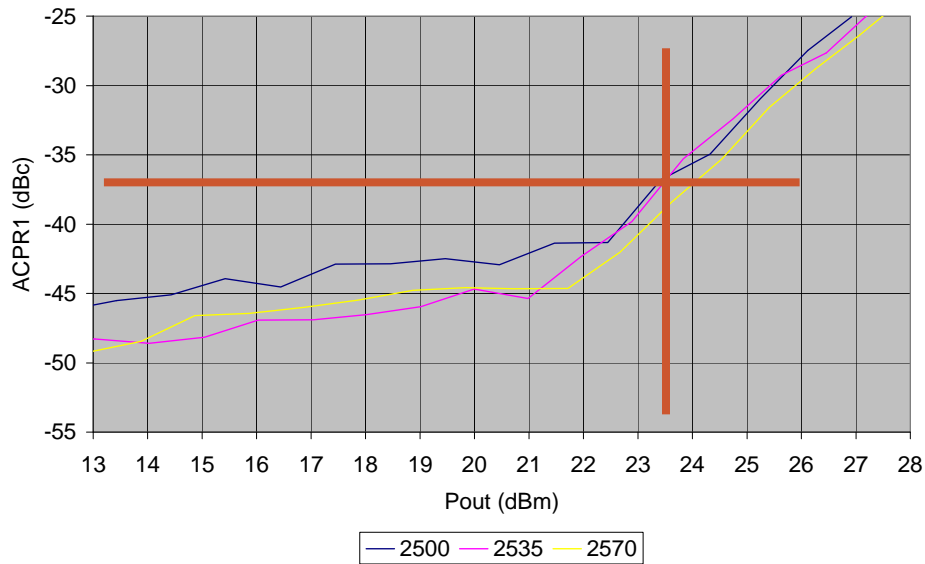

WCDMA

ACPR1: WCDMA

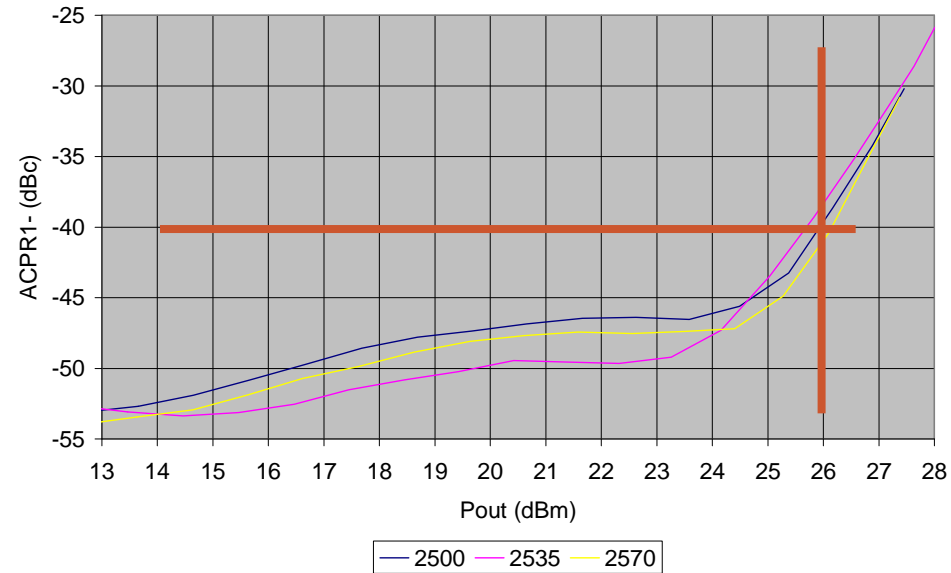

~2.5-3dB higher WCDMA linear power required to meet LTE linearity

FEM EVM Performance

16QAM, 10MHz BW, 50 Resource Blocks

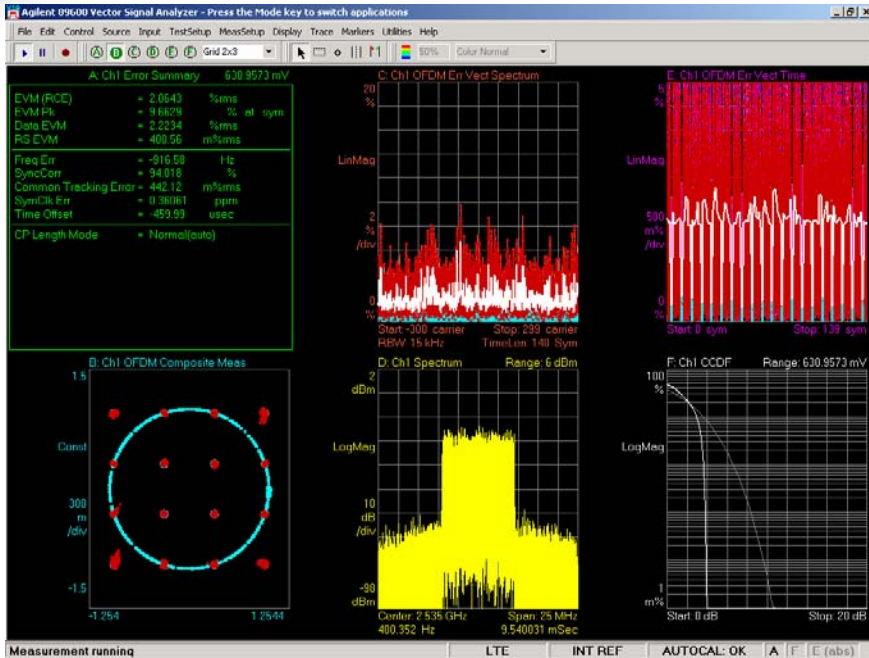

Pout=23dBm

SKY77445 EVM, 3.3V, 2535MHz

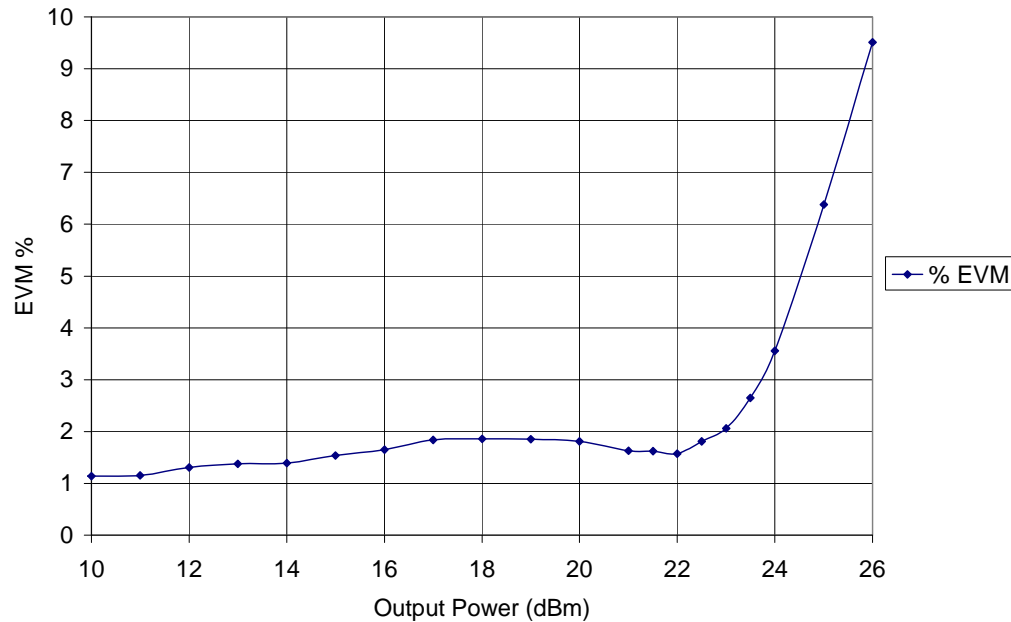

GaAs BiFET Technology – Key Enabler to Achieving PA Linearity

Small-Signal Performance

TX

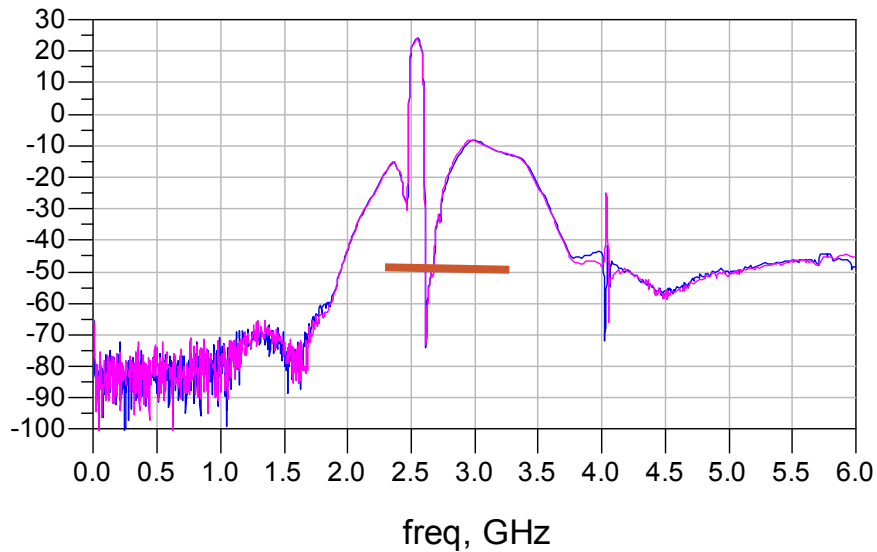

>70dB transition over 50MHz !

To achieve excellent TX attenuation in RX Band

RX

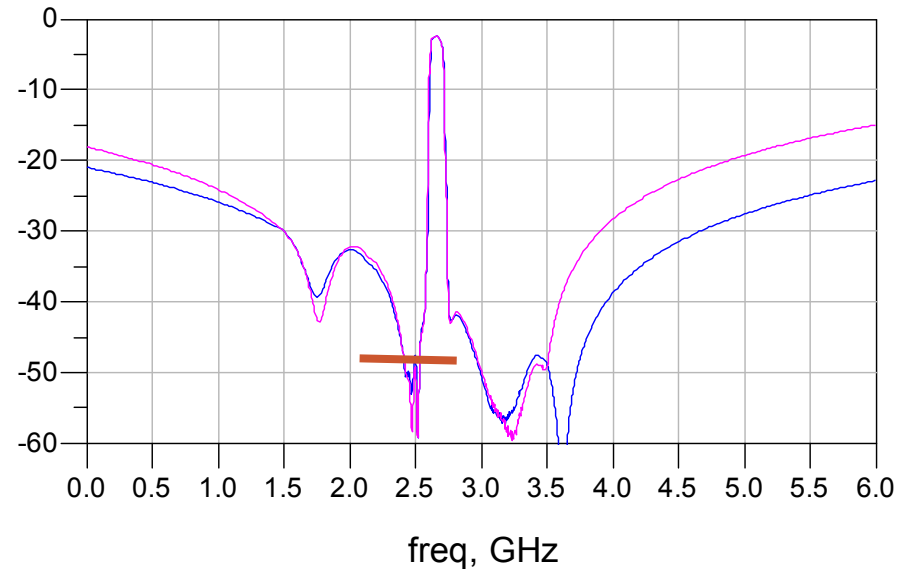

BAW Filter Technology – Key Enabler to Achieving Low Filter Loss with Excellent Out of Band Attenuation and Isolation

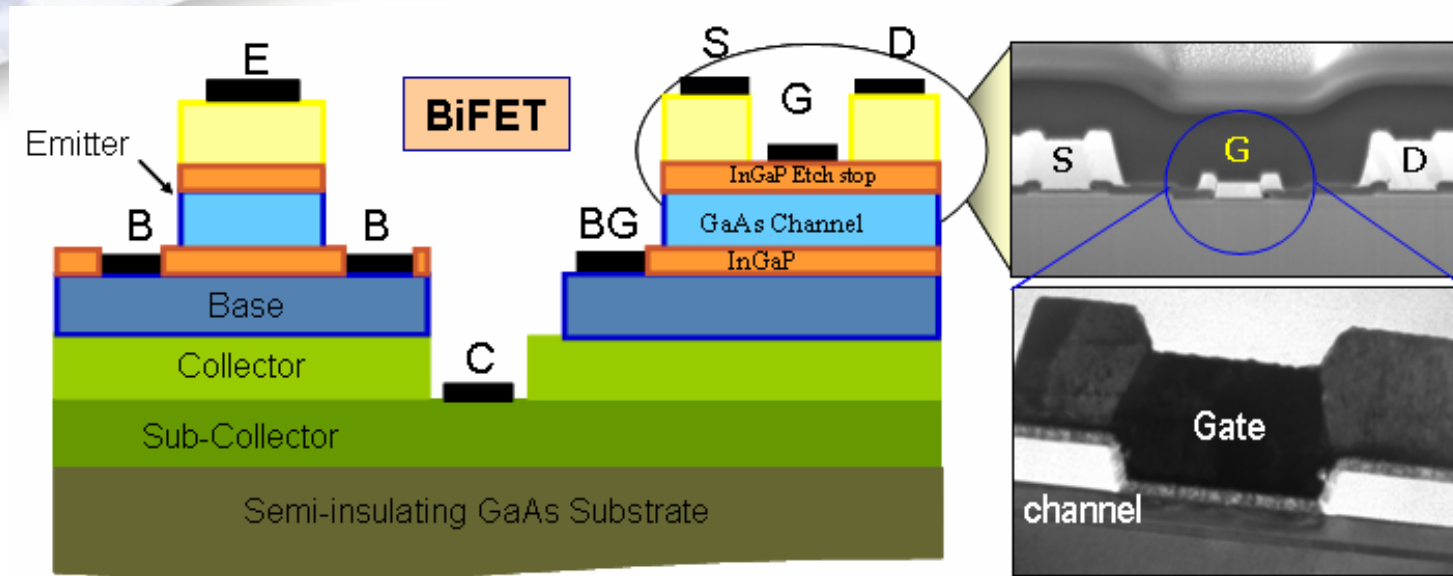

- MESFET added to baseline HBT process with minimal cost/yield impact
- Additional masking layer for channel definition, gate definition integrated into HBT flow
- Enables advanced bias network approaches for low voltage high linearity amplifiers
- Is extensively used in CDMA, WCDMA, WiFi, WiMAX and LTE PA and FEM products

Enables Excellent FEM Linearity/Efficiency Performance

Bulk Acoustic Wave (BAW) Filter Technology

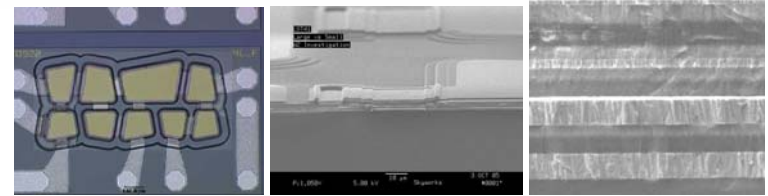
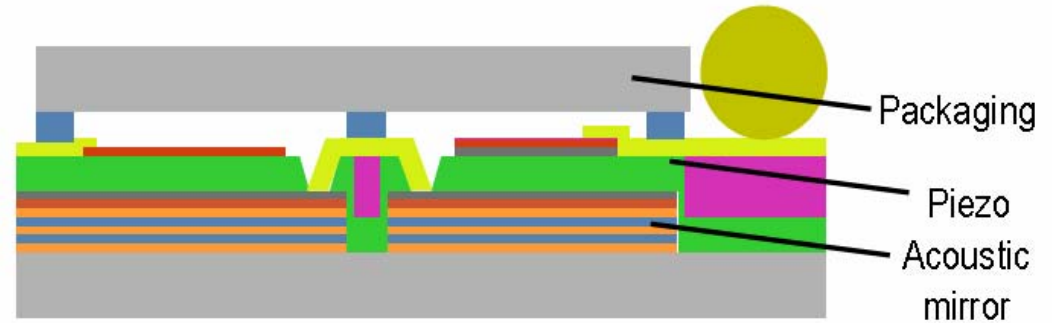
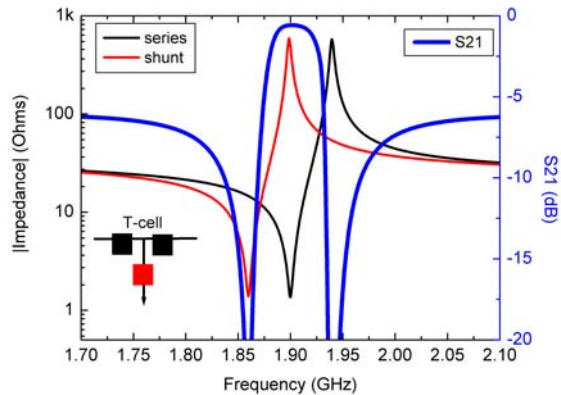

- Electromechanical filter technology:
- Electrical signals and vibration are coupled in piezoelectric materials (like Quartz.)
- BAW resonators are piezo-based sound-trapping structures fab'd using VLSI methods.
- Thickness of resonators dictate at which frequencies electrical signals can pass.
- Layout of resonator network into a filter determines specific pass/reject characteristics.

Enables Excellent FEM Loss/Rejection Performance

- **LTE is the next big standard (4G) after GSM and WCDMA**
- **Industry's First Front-End-Module for Band VII LTE applications was introduced**
- **State-of-the-art performance is achieved via integration and optimal matching of individual components and use of advanced technologies, such as GaAs/InGaP BiFET and BAW Filter**